

POWER SAVING SOLENOIDS

TM30P		
Voltage	Order code	Power
24 V AC/DC	295555	0.7 W
12 V AC/DC	295557	0.6 W
9 V AC/DC	295558	0.6 W

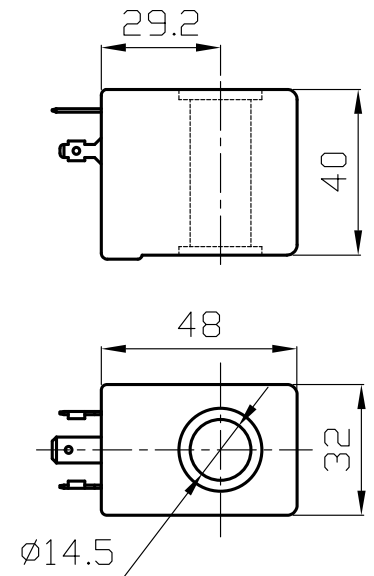

Connector: Form A - EN 175301-803 / ISO 4400 / ex-DIN 43650

TM35P		
Voltage	Order code	Power
24 V AC/DC	297555	1.1 W
12 V AC/DC	297552	1.7 W
9 V AC/DC	297541	1.1 W

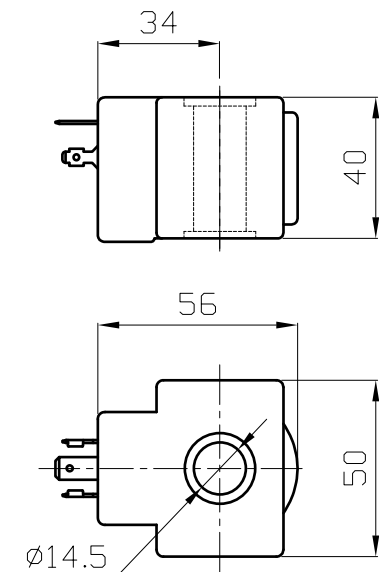

TM35H		
Voltage	Order code	Power
24 V AC/DC	297554	80 W pull 4 W hold
12 V AC/DC	297553	55 W pull 2.5 W hold

Connector: Form A - EN 175301-803 / ISO 4400 / ex-DIN 43650

Features

- with built-in power saving electronic circuit
- power consumption reduced by **up to 95%**
- rated power **0.6 to 4 W**
- lower operating costs
- extended life due to reduced heating
- preserved flow and pressure ratings of the valve
- compatible with most of our solenoid valve range
- quiet AC operation
- available voltages: 9, 12, 24 V
- minimum off time between cycles: 1 s

1. STANDARD TYPES

	TM25		TM25/S	
	Standard power		Low power & heating	
Voltage	Order code	Power	Order code	Power
230 V AC	296104	6 W	296105	4 W
115 V AC	296601	6 W	-	-
48 V AC	296201	6 W	296203	4 W
24 V AC	296301	6 W	296303	4 W
24 V DC	296400	6 W	296403	5 W
12 V DC	296501	9 W	296503	5 W

Connector: Form B - EN 175301-803 / ISO 6952 / ex-DIN 43650

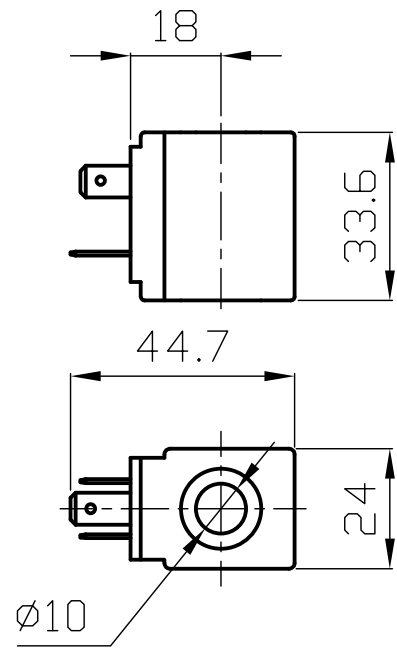

	TM30		TM30/S	
	Standard power		Low power & heating	
Voltage	Order code	Power	Order code	Power
230 V AC	295102	10 W	295104	7 W
115 V AC	295600	10 W	-	-
48 V AC	295200	10 W	295210	7 W
24 V AC	295300	10 W	295303	7 W
24 V DC	295401	10 W	295403	7 W
12 V DC	295500	10 W	-	-
400 V AC	-	-	295710	7 W

Connector: Form A - EN 175301-803 / ISO 4400 / ex-DIN 43650

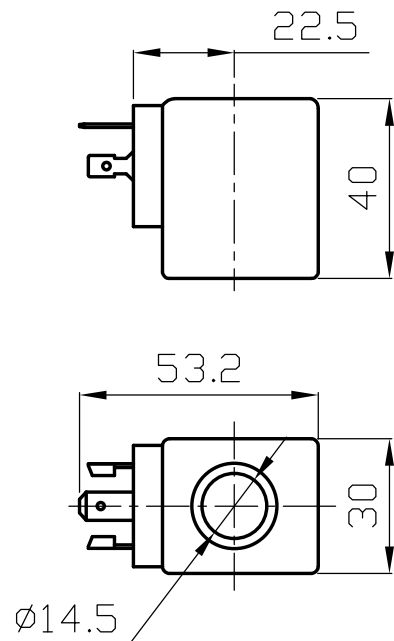

	TM35		TM35/S	
	Standard power		Low power & heating	
Voltage	Order code	Power	Order code	Power
230 V AC	297100	16 W	297102	8 W
115 V AC	297600	16 W	-	-
48 V AC	297202	16 W	-	-
24 V AC	297300	16 W	297302	8 W
24 V DC	297400	18 W	297410	12 W
12 V DC	297500	18 W	297502	9 W
400 V AC	297710	16 W	-	-

Connector: Form A - EN 175301-803 / ISO 4400 / ex-DIN 43650

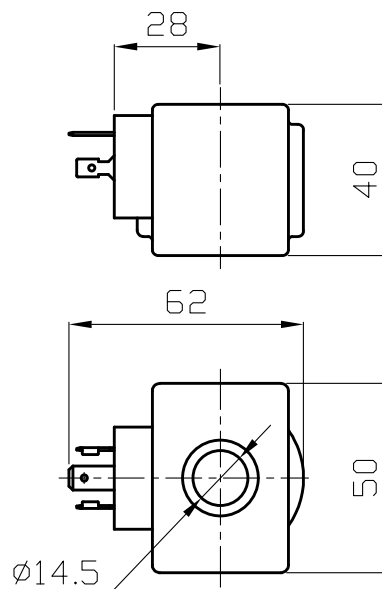

	TM40/S	
	Low power & heating	
Voltage	Order code	Power
200 V DC*	298012	12 W
24 V DC	298042	22 W

Connector: Form A - EN 175301-803 / ISO 4400 / ex-DIN 43650

*Connected to 230 V AC through plug with built-in rectifier.

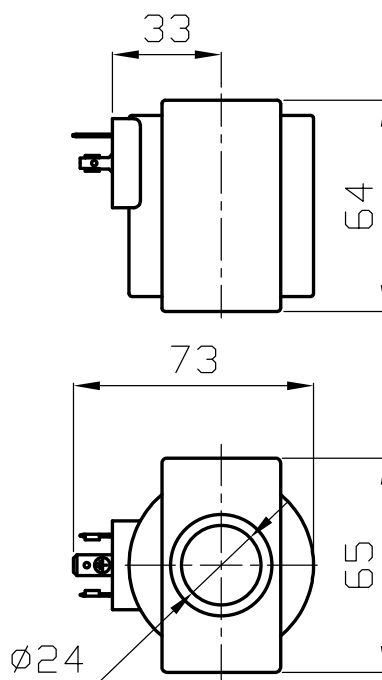

2. EXPLOSIONPROOF SOLENOIDS - rating II 2 G Ex eb mb IIC T4/T5 Gb (with ATEX certificate)



Suitable for any JAKŠA solenoid valve.

	TMEx35		TMEx40	
Voltage	Order code	Power	Order code	Power
230 V AC 200 V DC	290100	10 W	290110	15 W
115 V AC/DC	290106	10 W	290116	15 W
48 V AC/DC	290102	10 W	290112	15 W
24 V AC/DC	290103	10 W	290113	15 W
12 V AC/DC	290107	10 W	-	-

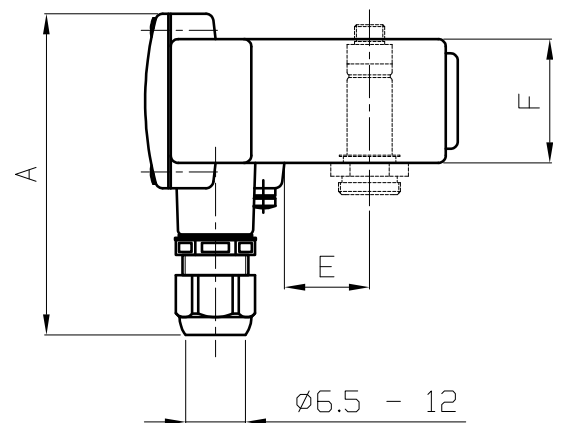
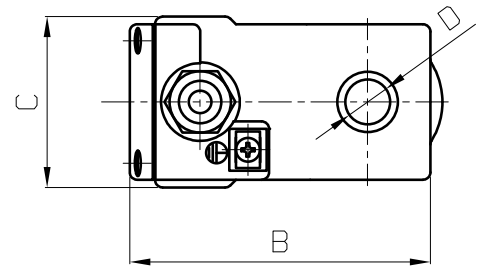

Dimensions [mm]	TMEx35	TMEx40
A	108	134
B	105	110
C	51	71
D	15	24
E	28.5	33
F	42	66
Mass [kg]	0.5	0.95



Special feature: encapsulated tube fuse for added safety and ease of use.

3A. SOLENOID FOR EXTREME UNDERWATER SERVICE – TYPE TM35kHP

- Designed to withstand long-term hydrostatic pressure up to 50 bar (500 m depth)
- IP rating: IP68
- Sea water resistant
- Voltages: 12 or 24 V DC (other voltages available on demand)
- Power: 80 W pull / 3-4 W hold
- Cable: PVC 3 x 0.75 mm² x 3 m length (other lengths available on demand)

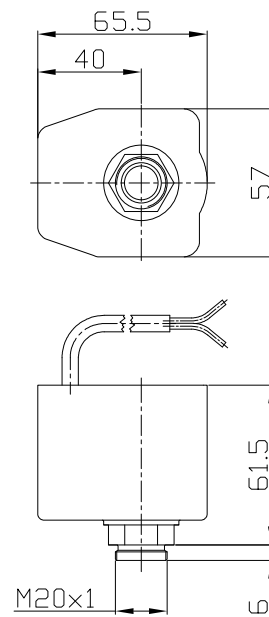

3B. SOLENOIDS FOR EXTREMELY HUMID AMBIENTS - rating IP67

TM30k		
Standard power		
Voltage	Order code	Power
230 V AC	295831	7 W
24 V AC	295833	7 W
24 V DC	295836	6 W
12 V DC	295838	10 W
6 V DC	295840	7 W

Cable: PVC 3 x 0.75 mm² x 3 m length
(Other lengths available on request)

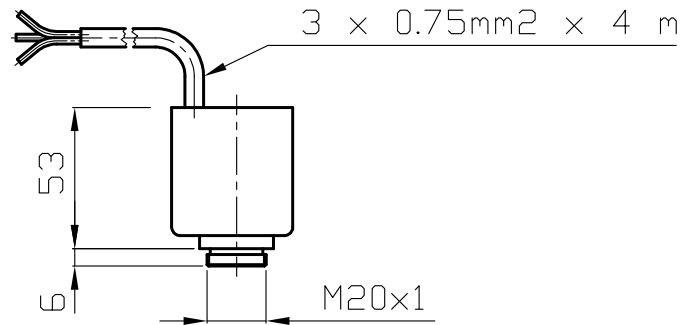
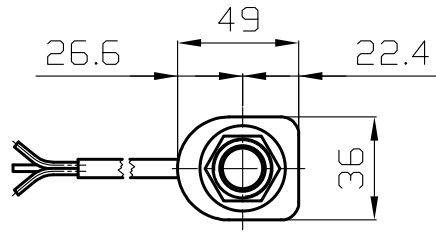

TM35k		
Low power & heating		
Voltage	Order code	Power
115 V DC	297872	4.5 W
24 V DC	297870	4.5 W

Cable: PVC 3 x 0.75 mm² x 3 m length
(Other lengths available on request)

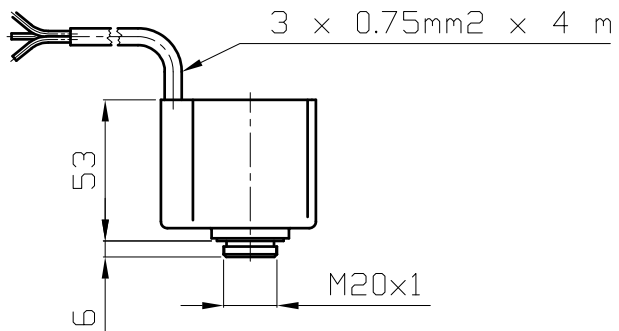
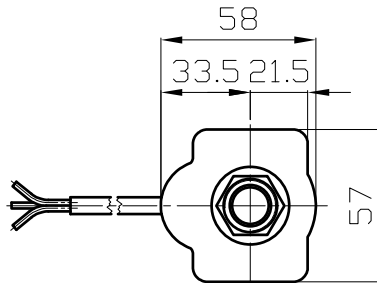

4. SOLENOIDS WITH DIN 72585-A1-2.1 CONNECTOR

	TM25b		TM30b	
Voltage	Order code	Power	Order code	Power
24 V DC	296860	6 W	295860	10 W
12 V DC	296862	6 W	295870	10 W

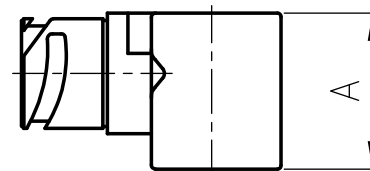

Dimensions [mm]:

Type	A	B	C	D	E
TM25b	33.6	24	41	10	15
TM30b	40	30	44	14.5	19

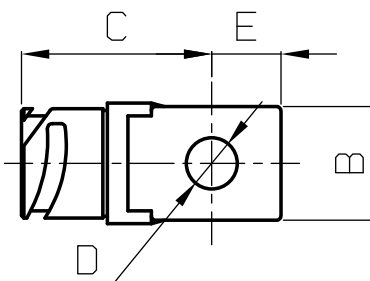

Connector: DIN 72585-A1-2.1
(Other 2-pole variants possible on request)



5. SEALING SETS FOR HUMID AMBIENTS

Set consists of O-rings or profiled seals and brass nut.
Seals are placed onto solenoid base, under and above solenoid and fixed with brass nut.
Properly fitted sealing set prevents damp intrusion into solenoid.

Solenoid	Set order code
TM30, TM35, TMEx35	298237 for 2/2 valves 298239 for 3/2 valves
TM40, TMEx40	298227



6. CONNECTORS (Form A or B - EN 175301-803 / ISO 4400 / ex-DIN 43650)

Solenoid	Set order code	Fig.
TM25	190010	1
TM30/TM35/TM40	190001 190009 (with rectifier)	2

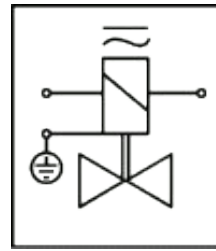

- M3 bolt and NBR gasket included.
- Ambient temp. -25° to +80°C.
- Cross section of conductor 0.5 - 1.5 mm²
- Cable not included.

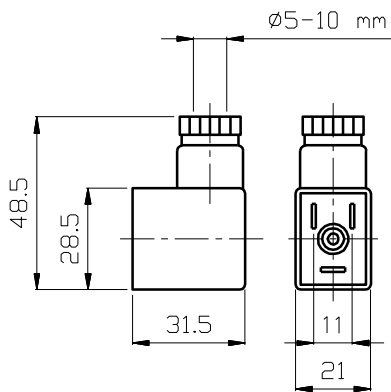

Fig. 1

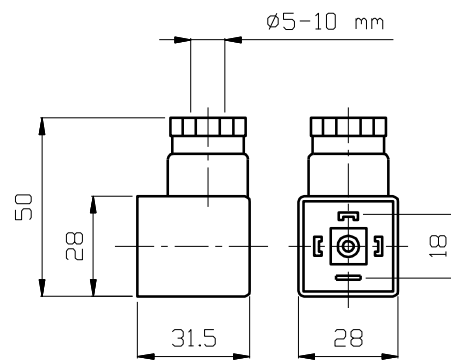

Fig. 2

